

# FX-i FX-iWP Series



**AND** ...Clearly a Better Value  
A&D WEIGHING

# Realizing Compact, Increasing Functions!

We have developed a Miniaturized SHS\* (Super Hybrid Sensor) to achieve a highly compact precision balance, which is 40% lighter and 47% smaller than our GF series with a 25% smaller footprint, while maintaining A&D's superior weighing functions. \*Patent Pending



**FX-120i**  
122gx1mg

**FX-200i**  
220gx1mg

**FX-300i**  
320gx1mg

**FX-1200i**  
1220gx10mg

**FX-2000i**  
2200gx10mg

**FX-3000i**  
3200gx10mg

# FX-i



## Response Indicator Function

Selectable FAST, MID or SLOW response to suit weighing environment conditions

## Comparator Function

Easy to compare weighing results by setting HI limit and LO limit to display HI,OK,LO indicator

## ACAI – Automatic Counting Accuracy Improvement

This counting function recalculates the average unit weight each time a sample is added to eliminate errors caused by variations in unit weight

## Percent Mode Function

A sample can be registered as 100% and the weight of another sample can be compared as a percentage

## *B5 Size Footprint*

Ideal for installation and use in narrow spaces

## *Compact SHS-1 Second Stabilization*

Quick stabilization speed with accurate weighing for better productivity

## *Shock Absorber Function\**

The internal shock absorber protects the SHS from the adverse effects of vertical or transverse overloading. \*Patent Pending

## *Quick USB Interface (FXi-02)*

Easy-to-use optional USB interface, **with no driver installation necessary**, for transfer of weighing data to a computer (applicable OS – Windows 98 OSR2 or later)

## *SCF-Statistical Calculation Function*

Can display and/or output statistical calculation data as No. (number of data), SUM (total), MAX (maximum), MIN (minimum), R [range (maximum – minimum)], AVE (average), SD (standard deviation) and CV (coefficient of variation)

## *LAN-Ethernet Interface (FXi-08) with WinCT-Plus Software*

WinCT-Plus software makes it possible for the user to easily set up an IP address, subnet mask etc. The user can also send commands for control and acquisition of data from multiple FX-i balances.

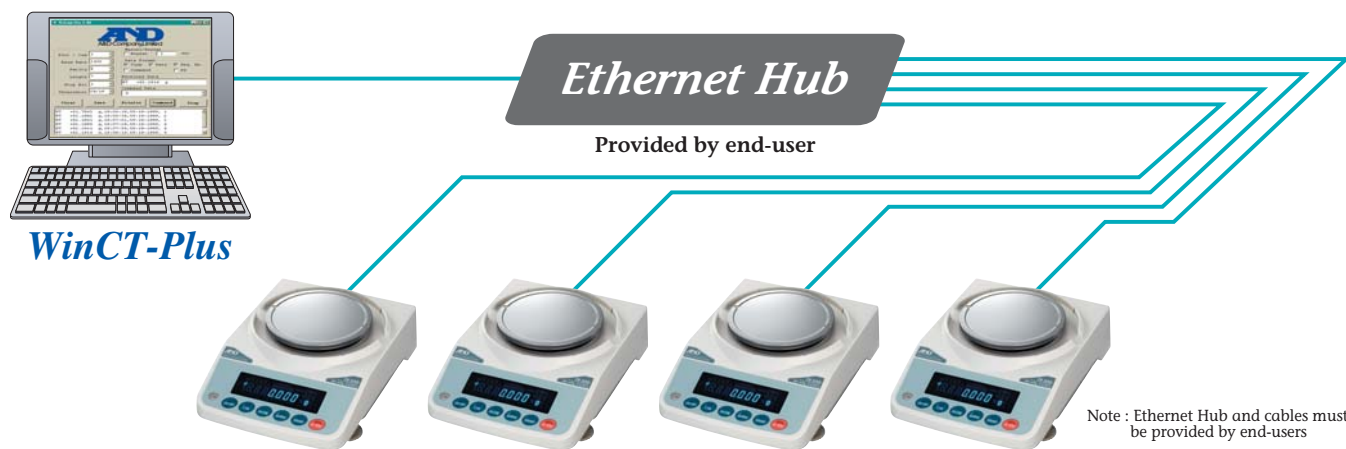

### **Animal Weighing Function**

The HOLD function enables freezing of weighing data for animal weighing applications and an ANIMAL indicator appears on the display

### **Underhook**

The underhook, for hanging applications, allows for measurement of magnetic materials and density measurements in air and water

### **Standard RS-232C Interface**

Incorporates bi-directional communication with a PC, printer or other peripheral devices

### **Multiple Weighing Units of Measurement**

Programmable or standard weighing units of measurement can be selected; g, pcs, %, oz, lb, L oz, ozt, ct, mom, dwt, GN, tl, tol, mes and MLT

# The World's First IP65 Compliant, Water / Dust Proof Precision (1mg) Balance!

Yet another breakthrough from A&D enabling the measurement of liquid or powder at 1mg resolution, eliminating any worries about damage to the balance



**FX-120iWP**  
122gx1mg

**FX-200iWP**  
220gx1mg

**FX-300iWP**  
320gx1mg

**FX-1200iWP**  
1220gx10mg

**FX-2000iWP**  
2200gx10mg

**FX-3000iWP**  
3200gx10mg

# FX-iWP



## GLP/GMP/GCP/ISO Compliant

In accordance with GLP and LIMS regulations, the balance ID number and calibration data can be printed out using A&D's AD-8121B or a PC

## Auto Power OFF Function

The display switches OFF automatically when the balance is inactive for 10 minutes as a power-saving tool

## Auto Power ON Function

The weighing mode display activates automatically with AC power so there is no need to press the ON/OFF key

## Built-in Rechargeable Battery (FXi-09)\*

An optional Ni-MH rechargeable battery pack can be fitted into the FX-i series for use without AC power and for mobile applications (10 hours charging time for 8 hours operation)

\* Not IP65 compliant when used with FX-iWP



*IP65 means that this kind of measurement is possible.*



*Highly Visible Display*



*Firmly Sealed Pan Support*



*Water Proof RS-232C Cable (optional)*



*Large Breeze Break (optional)*

The small breeze break comes as standard with the FX-120i(WP), FX-200i(WP) and FX-300i(WP), which are all 1mg resolution models.

## Specifications

	FX-120 i FX-120 iWP	FX-200 i FX-200 iWP	FX-300 i FX-300 iWP	FX-1200 i FX-1200 iWP	FX-2000 i FX-2000 iWP	FX-3000 i FX-3000 iWP
Weighing capacity	122g	220g	320g	1220g	2200g	3200g
Minimum weighing value	0.001g		0.01g			
Counting mode	Minimum unit mass		0.001g			
	Number of samples		5, 10, 25, 50 or 100 pieces			
Percent mode	Minimum 100% reference mass		0.001g		1.00g	
	Minimum 100% display		0.01%, 0.1%, 1% (depends on the reference mass stored)			
Repeatability (Standard Deviation)	0.001g		0.01g			
Linearity	±0.002g		±0.02g			
Stabilization time (typically set at FAST)	Approx. 1 second					
Sensitivity drift (10 °C to 30 °C)	±2ppm/°C					
Operating temperature	5°C to 40°C (41°F to 104°F), 85%RH or less (no condensation)					
Display type	Vacuum Fluorescent Display (VFD)					
Display refresh rate	5 times /second, 10 times /second or 20 times /second					
Standard serial interface	RS-232C Interface					
Weighing pan (diameter)	130mm			150mm		
External calibration mass	100g 50g	200g 100g	300g 200g 100g	1000g 500g	2000g 1000g	3000g 2000g 1000g
AC adaptor	Confirm that the adaptor type is correct for the local voltage and power receptacle					
Power consumption	Approx. 11VA (supplied to the AC adaptor)					
External dimensions	193 (W) X 262.5 (D) X 85.5 (H) mm					
Net weight	FX- <i>i</i> Approx. 2.5kg / FX- <i>i</i> WP Approx. 2.7kg					

## Options

FX <i>i</i> -02*	Quick USB interface with cable
FX <i>i</i> -08*	Ethernet interface with WinCT-Plus software
FX <i>i</i> -09*	Built-in rechargeable battery
FX <i>i</i> -10	Small breeze break
FX <i>i</i> -11	Large breeze break
FX <i>i</i> -WP-10	Small breeze break (gray)
FX <i>i</i> -WP-11	Large breeze break (gray)
FX <i>i</i> -12	Animal weighing pan
FX <i>i</i> -15	Carrying case

\* FX *i*-02, FX *i*-08 and FX *i*-09 cannot be used at the same time.  
(Not IP65 compliant when used with FX-*i*WP)

## Accessories

AD-1683	Static eliminator
AD-8920*	Remote display
AD-8922*	Remote controller
AD-8121B*	Compact printer
AD-8526*	RS/Ethernet converter
AX-CARATPAN	Carat pan
AX-KO2737-500-EX	Waterproof RS-232C cable (5m)

\* (Not IP65 compliant when used with FX-*i*WP)



AD-8121B

## External Dimensions

(mm/inches)

Pan size	A
FX-120 <i>i</i> (WP) / 200 <i>i</i> (WP) / 300 <i>i</i> (WP)	130 / 5.12
FX-1200 <i>i</i> (WP) / 2000 <i>i</i> (WP) / 3000 <i>i</i> (WP)	150 / 5.91

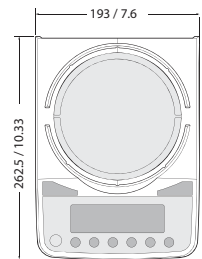
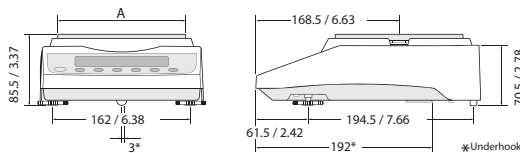

## Dimensions with Small Breeze Break

(FX *i*-10/FX *i*-WP-10)

(Comes equipped with FX-120 *i*(WP)/200 *i*(WP)/300 *i*(WP))

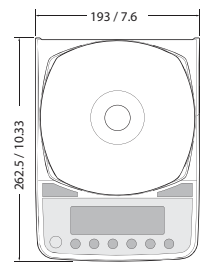
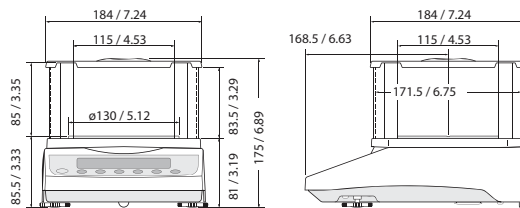

## Dimensions with Large Breeze Break

(FX *i*-11/FX *i*-WP-11)

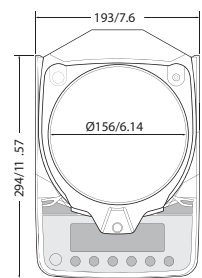
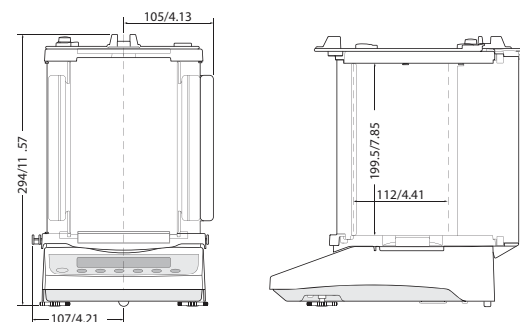

**C&M SCALE**  
 Website: [www.cmscale.com](http://www.cmscale.com)  
 Email: [support@cmscale.com](mailto:support@cmscale.com)

Toll Free: (800) 243-3721  
 In Chicago: (708) 771-0195  
 Fax: (708) 771-0195